

# Architectural emergency lighting

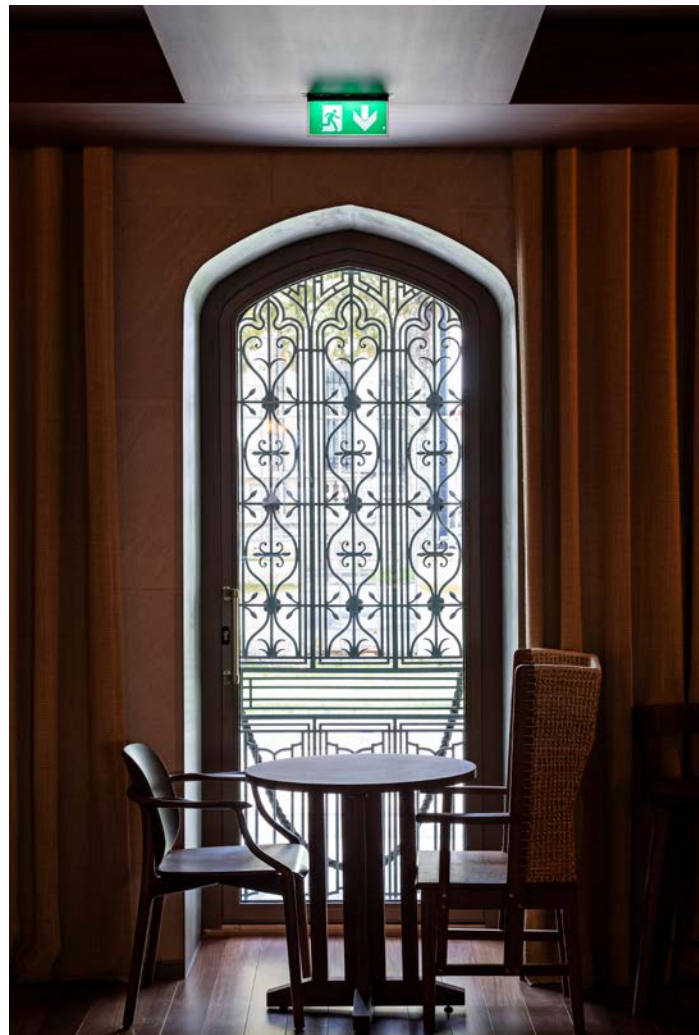



Béhar designs and manufactures high-end emergency lighting that integrates seamlessly into every architectural project

Our expertise, combining technical know-how and innovation, enables us to offer customised solutions for the aesthetic integration of emergency lighting across all architectural environments.

Designed and manufactured in France, our luminaires combine design, reliability, and durability. Their repairable and upgradeable design extends their life cycle while complying with building standards and aesthetic requirements.

# Design for all architectures

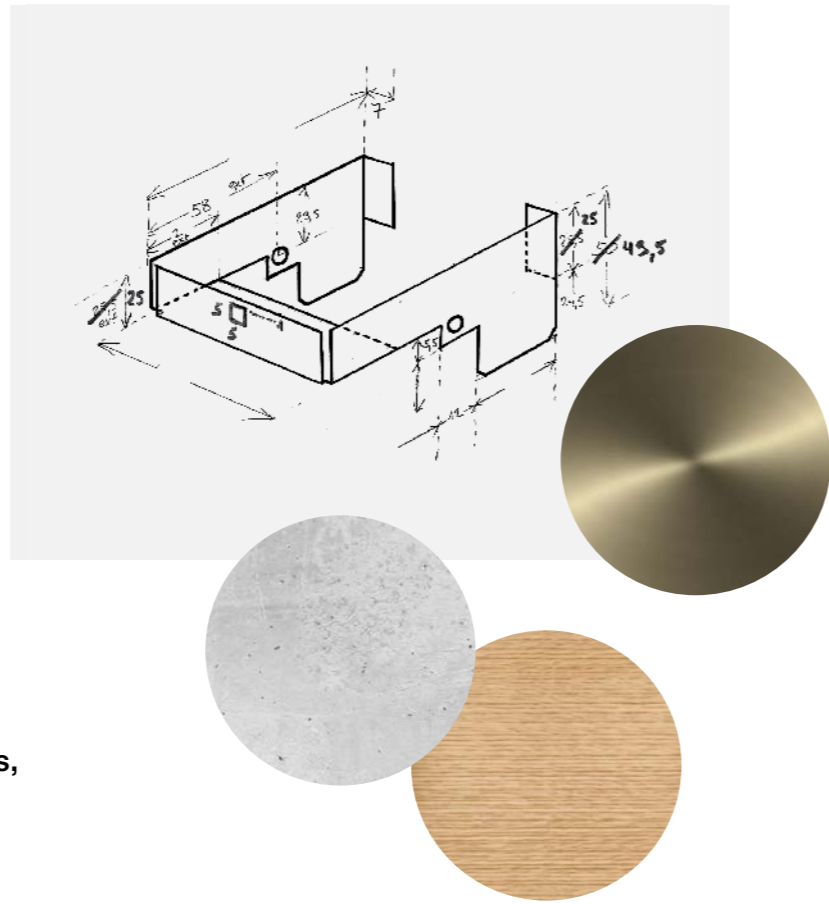
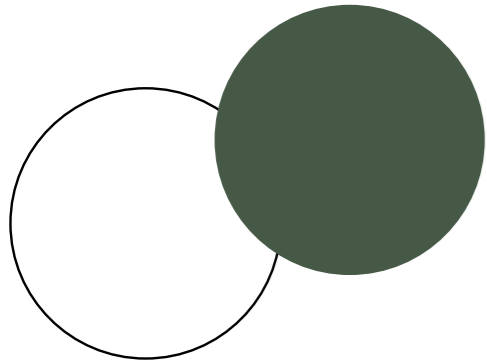

Since 1960, Béhar has been designing emergency lighting fixtures with clean lines, made from sustainable materials. They blend naturally into any architectural environment.

Every detail can be customized: shape, color, finish, mounting type, accessories, surface treatment, etc., to meet the aesthetic requirements of each project.

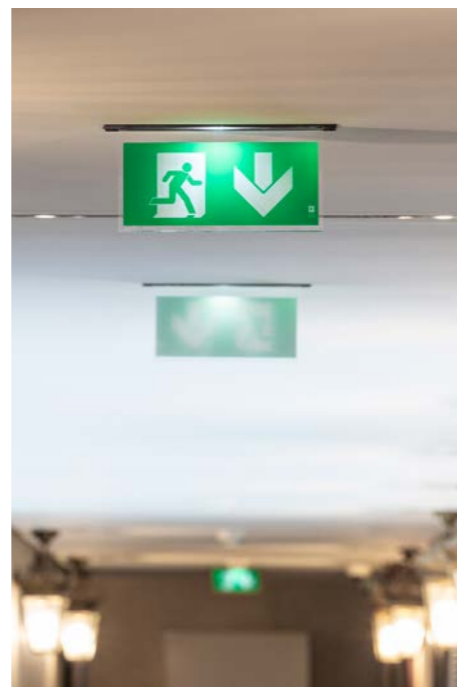

# Customization



Endless customization — each product can be tailored to the needs of your project and the specific characteristics of the building.

Creation and customization of pictograms to ensure consistent wayfinding throughout the entire building.

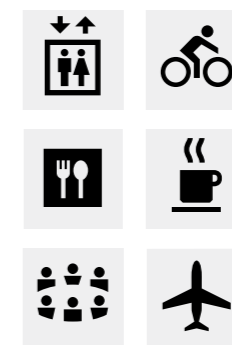

# Our emergency lighting solutions

All our solutions are available in addressable, self-test, power central source, and self-test bi-function versions. Custom solutions and special finishes available on request.

A non-exhaustive selection of our solutions — find our full range on our website :



## Architecture

### Luce

The most compact recessed model on the safety lighting market.

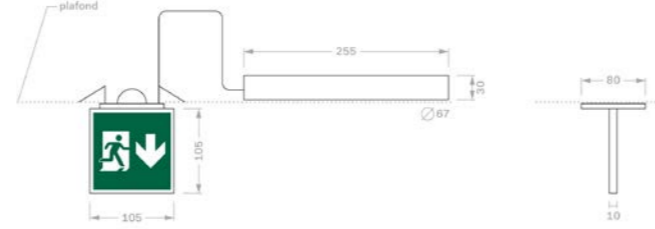

### Luce

Available in horizontal or vertical wall surface.

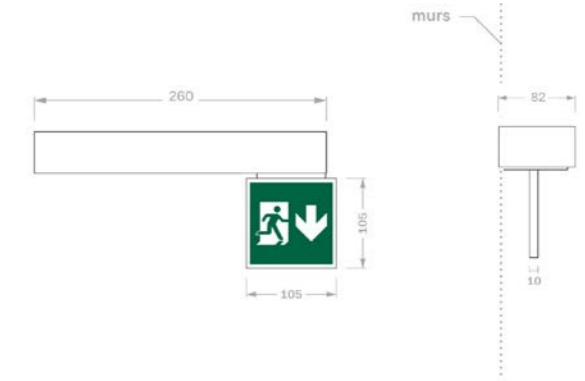

### Spark

Available in 7 mounting types and different sizes.

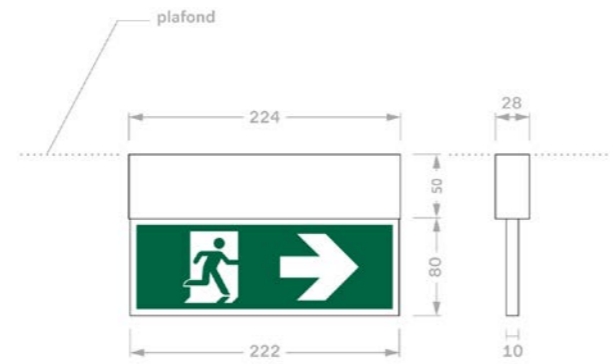

### Clas

Rounded corners, available in wall surface.



### Lou

Available as a wall-mounted or recessed model.

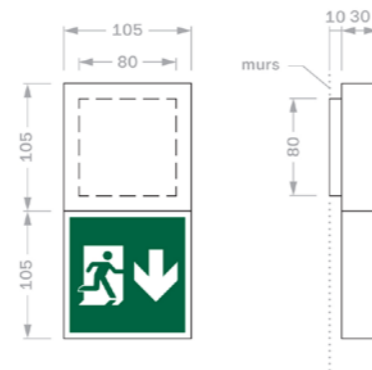

### Knopé

Solid oak wood, available in wall surface.

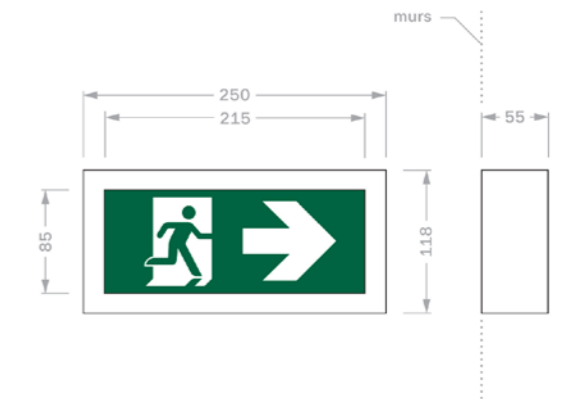

# Our emergency lighting solutions

All our solutions are available in addressable, self-test, power central source, and self-test bi-function versions. Custom solutions and special finishes available on request.

## Architecture

### Star



Available in wall surface or recessed wall.

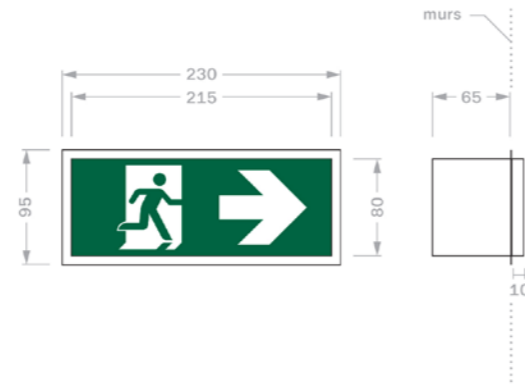

### Skape



Aluminum model available in surface or recessed.

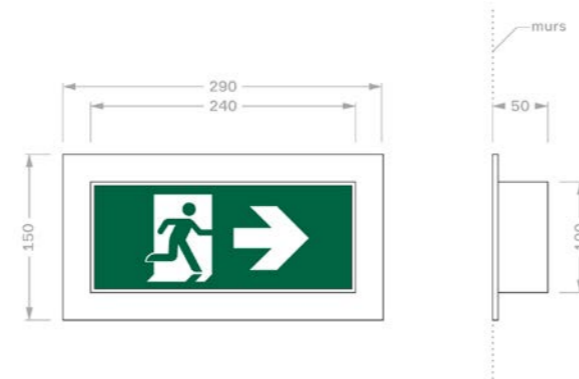

### Eclat



Steel trim, available in wall surface.

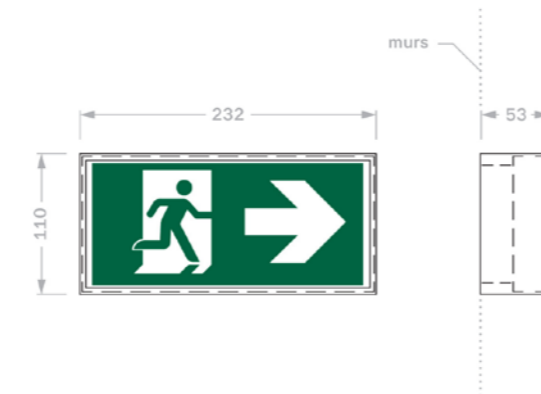

# Our anti-panic lighting solutions

All our solutions are available in addressable, self-test, power central source, and self-test bi-function versions.  
Custom solutions and special finishes available on request.

A non-exhaustive selection of our solutions — find our full range on our website :



## Architecture

### Luce

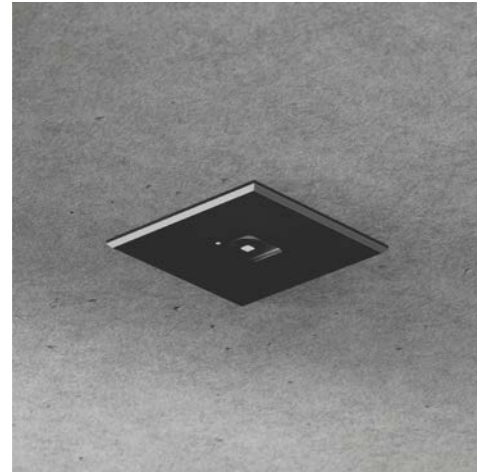

Available in square or round recessed ceiling.



### Luce



Surface-mounted model, high luminous flux.

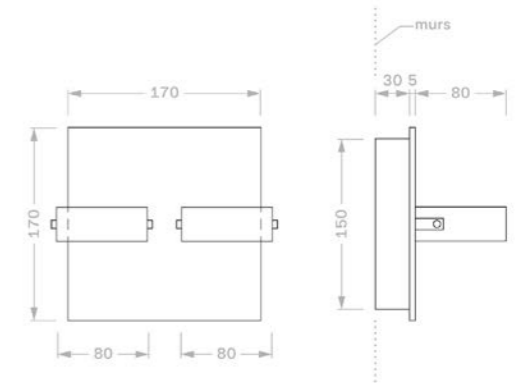

### Spark

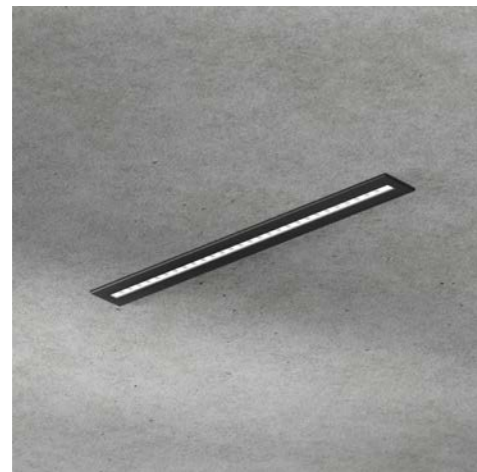

Available in 7 different installation types and sizes.

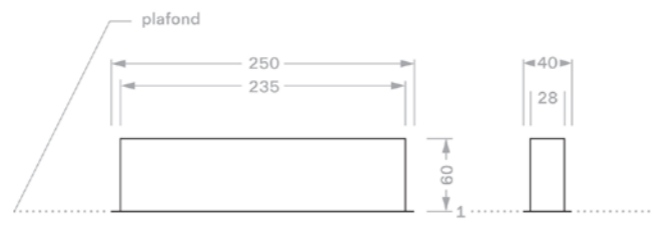

### Clas



Rounded corners, available in ceiling surface.



### Spark



Available in 7 different installation types and sizes.

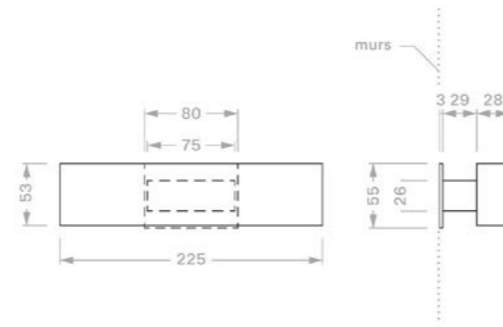

### Knopé



Solid oak wood, available in ceiling surface.

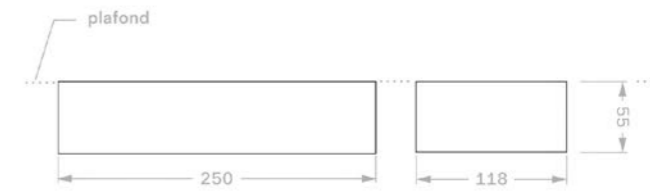

# Our specific sign lighting solutions

Customizable solutions and special finishes available upon request.

A non-exhaustive selection of our solutions — find our full range on our website :



## Architecture

### Spark



Available in 7 different installation types and sizes.

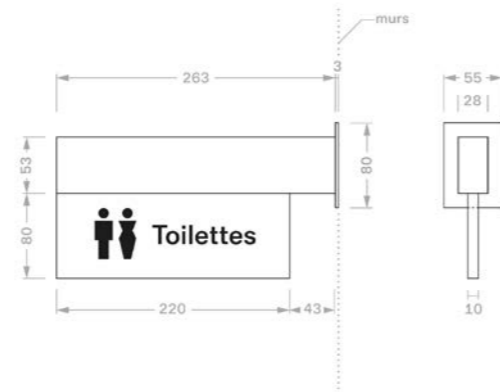

### Luce

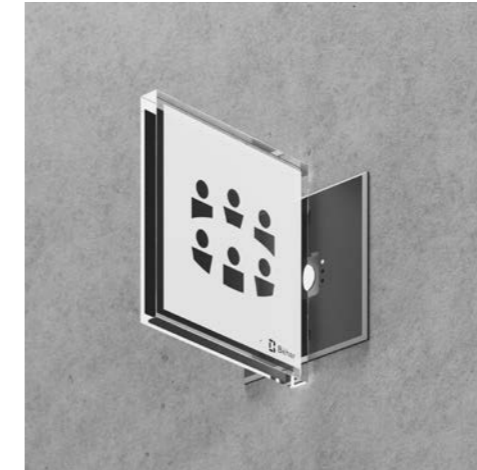

Available in round or square, recessed wall or ceiling.

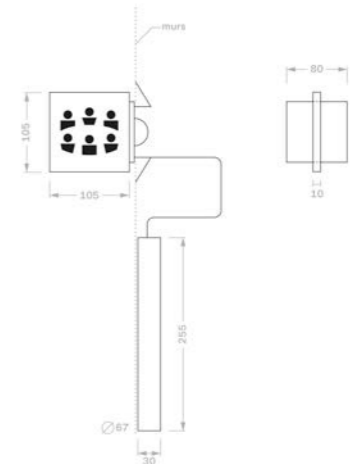

### Lou

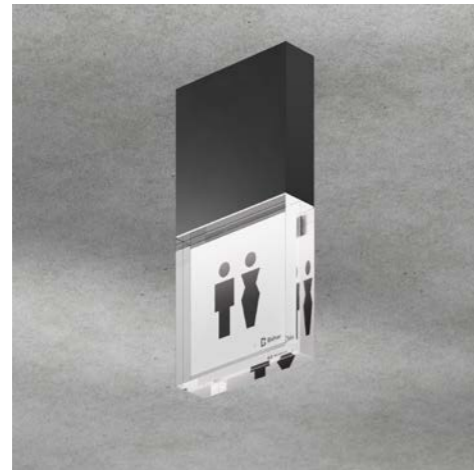

Available in wall or ceiling surface and recessed.

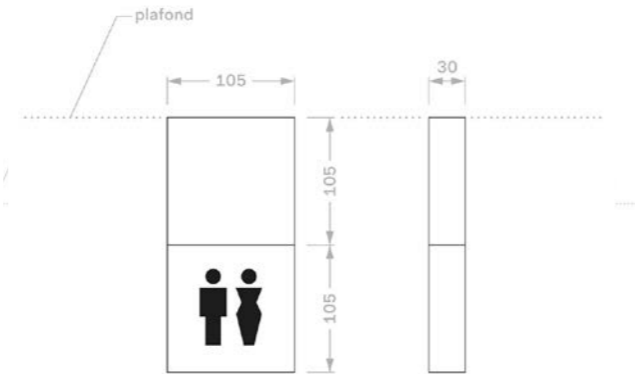

### Skape



Aluminum model available in surface or recessed.

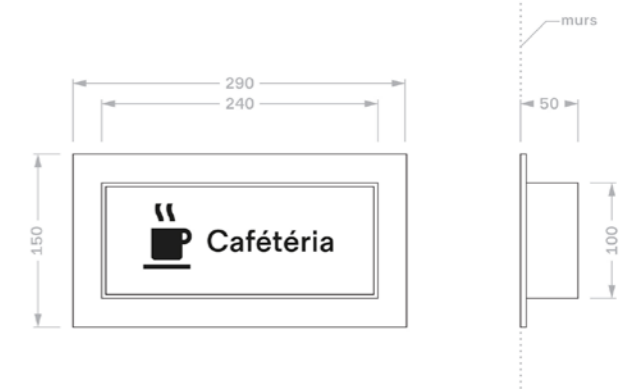

### Star



Available in wall surface or recessed.

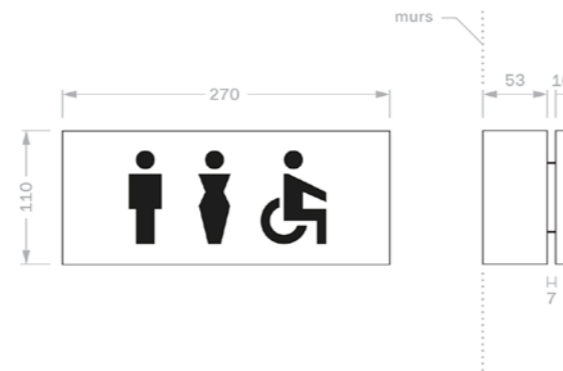

### Knopé



Solid oak wood, available in wall surface.

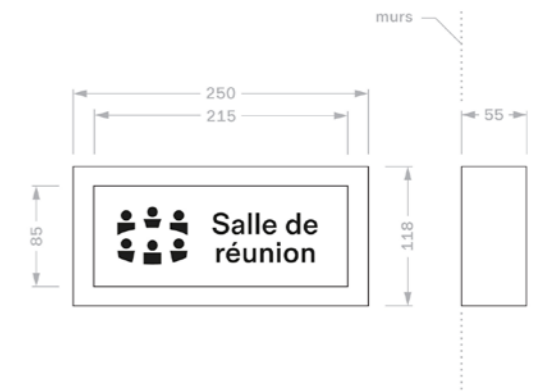

# Our emergency lighting solutions

All our solutions are available in addressable, self-test, power central source, and self-test bi-function versions.  
Custom solutions and special finishes available on request.

A non-exhaustive selection of our solutions — find our full range on our website :



## Technical

### Vista Cinéma



Developed in collaboration with the National Federation of French Cinemas.

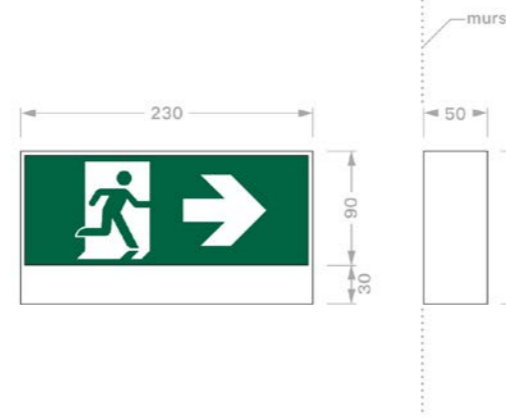

### Compact Triangulaire



Available in surface or recessed.

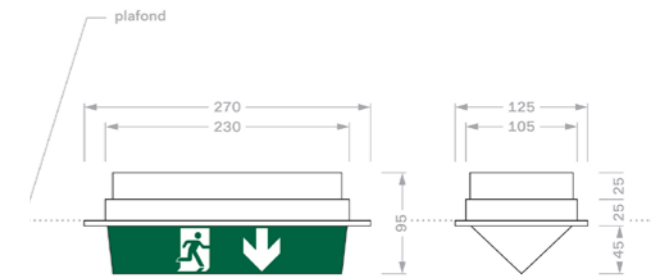

### Vista Opéra



Suitable for high-ceilinged auditoriums.

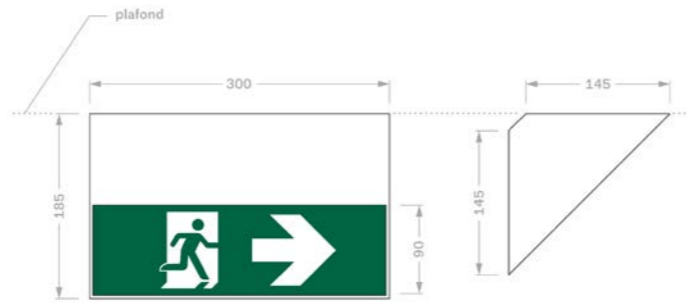

### Eclat<sup>2</sup> Grid



Protective grid available in surface or recessed.

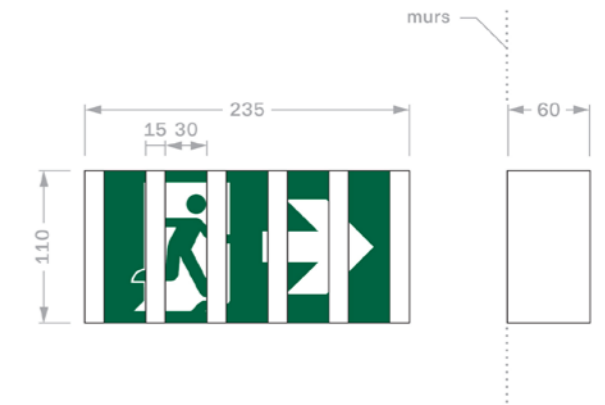

### Eclat<sup>2</sup>



Available in surface or recessed.

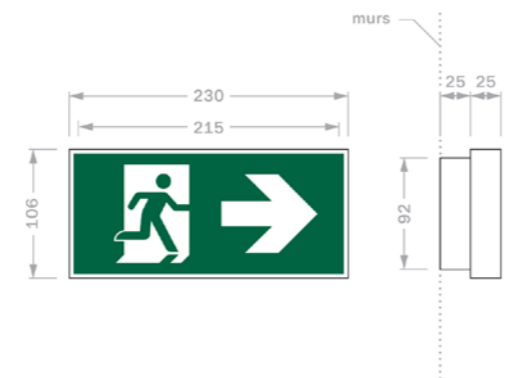

### Cylindrik



Stainless steel model, available in wall or ceiling surface, or suspended.

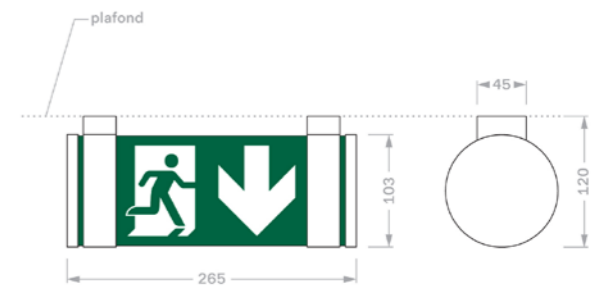

# Our anti-panic lighting solutions

All our solutions are available in addressable, self-test, power central source, and self-test bi-function versions.  
Custom solutions and special finishes available on request.

A non-exhaustive selection of our solutions — find our full range on our website :



## Technical

### Star



Optics suitable for dark rooms, available in ceiling surface.

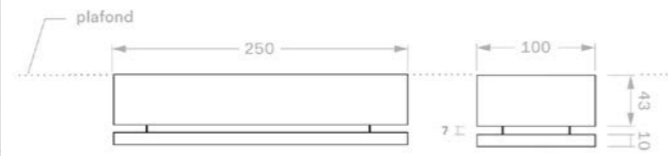

### Phare



Optimization of ambient lighting thanks to high luminous flux.

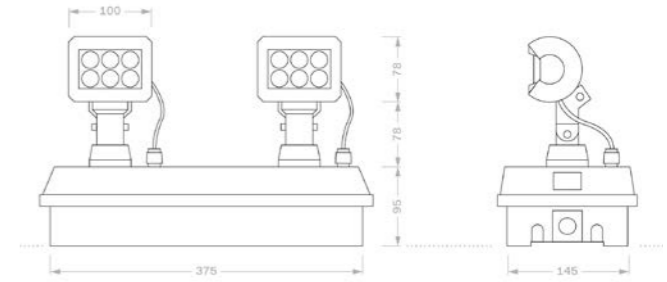

### Eclat<sup>2</sup>



Available in ceiling surface or recessed.

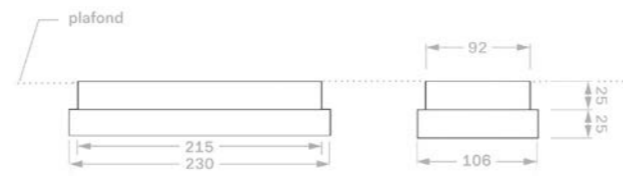

### Cylindrik



Stainless steel model, available in wall or ceiling surface, or suspended.

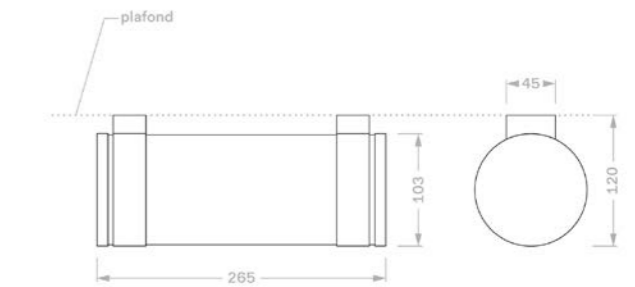

### Cylindrik



Available in ceiling surface or suspended.



### Réglette

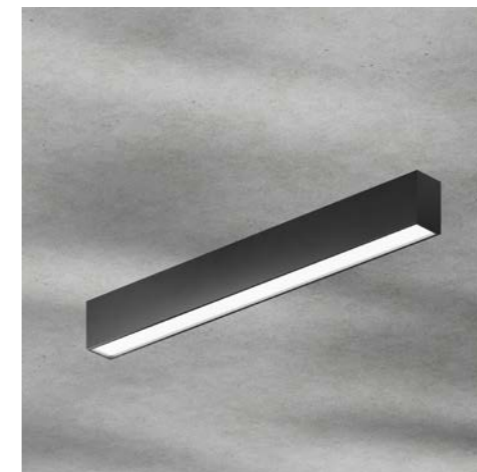

Available in ceiling surface or suspended.



# DiCube Smart System

Connected safety,  
simplified maintenance,  
and regulatory compliance.

## Smart and Connected Architecture

The system is built around a Hub module capable of controlling up to 10 consoles, connected via RS-485 (Modbus) or RJ45 (Ethernet). The consoles manage the supervision of lighting units using the DALI protocol. Thanks to its compatibility with a BMS such as EcoStruxure™ (Schneider Electric system, parent company of Béhar Sécurité), the DiCube Smart System integrates seamlessly into building management systems, providing centralized and optimized supervision.

## Simplified Supervision and Maintenance

The system automatically monitors up to 1,280 luminaires, detects anomalies, and reduces on-site interventions, in compliance with EN 62034.

## Regulatory Compliance

The system ensures compliance with the maintenance standards for emergency lighting (BAES and BAEH, NF C71-830), which require operators to perform monthly, semi-annual, and annual checks of emergency lighting while maintaining a security log.

A connected emergency lighting solution,  
monitored in real time.

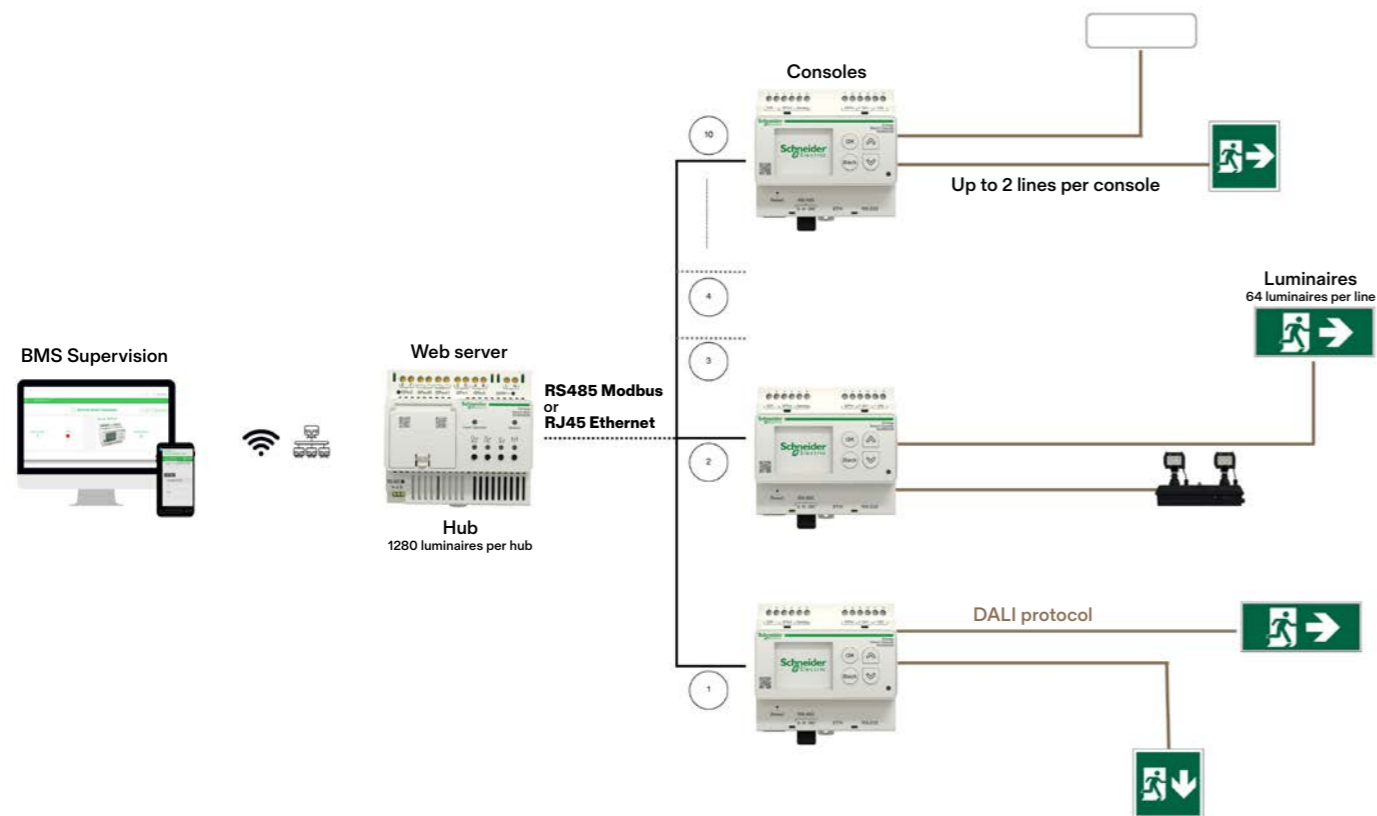



Morimoto Restaurant, Mondrian Bordeaux Les Carmes, Architecture - P. Starck, photo by I. Mathie, Spark collection

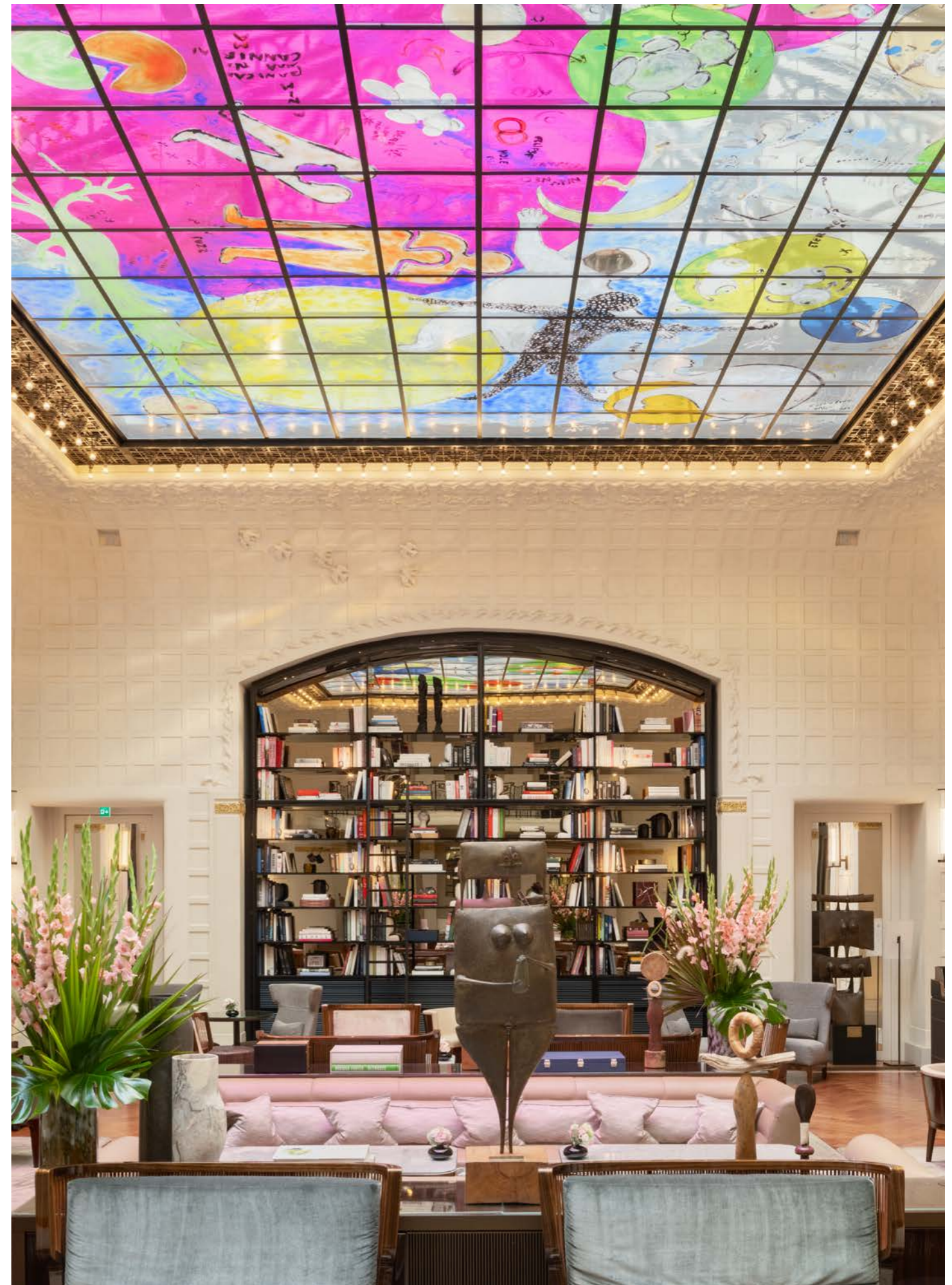

Hôtel Le Lutetia, Paris, Wilmotte & Associés, photo by J.Chulski, Lou collection

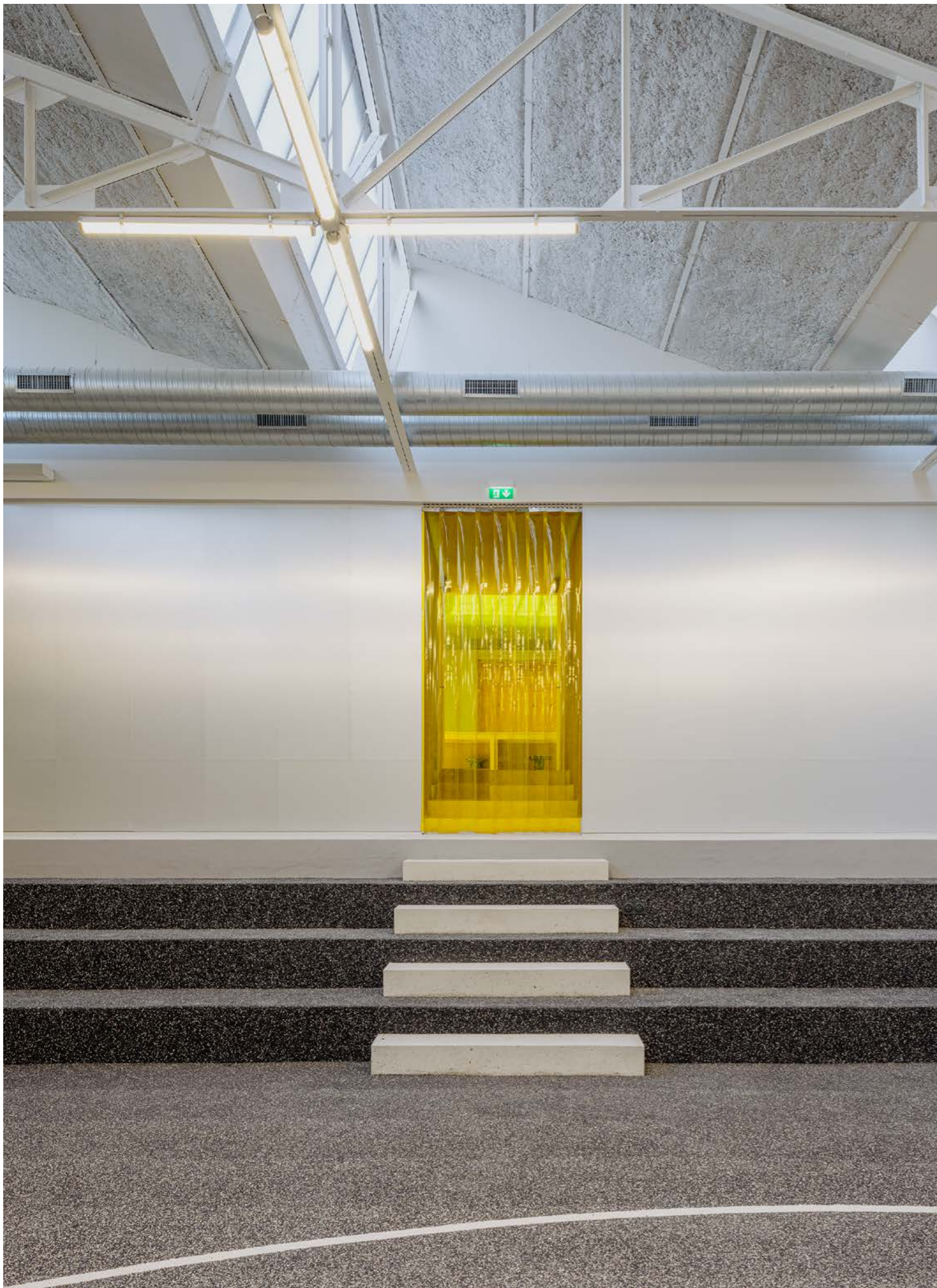

Yard headquarters, Montreuil, Exbrayat Enrico Architects, photo by J.B. Thiriet,  
Spark collection

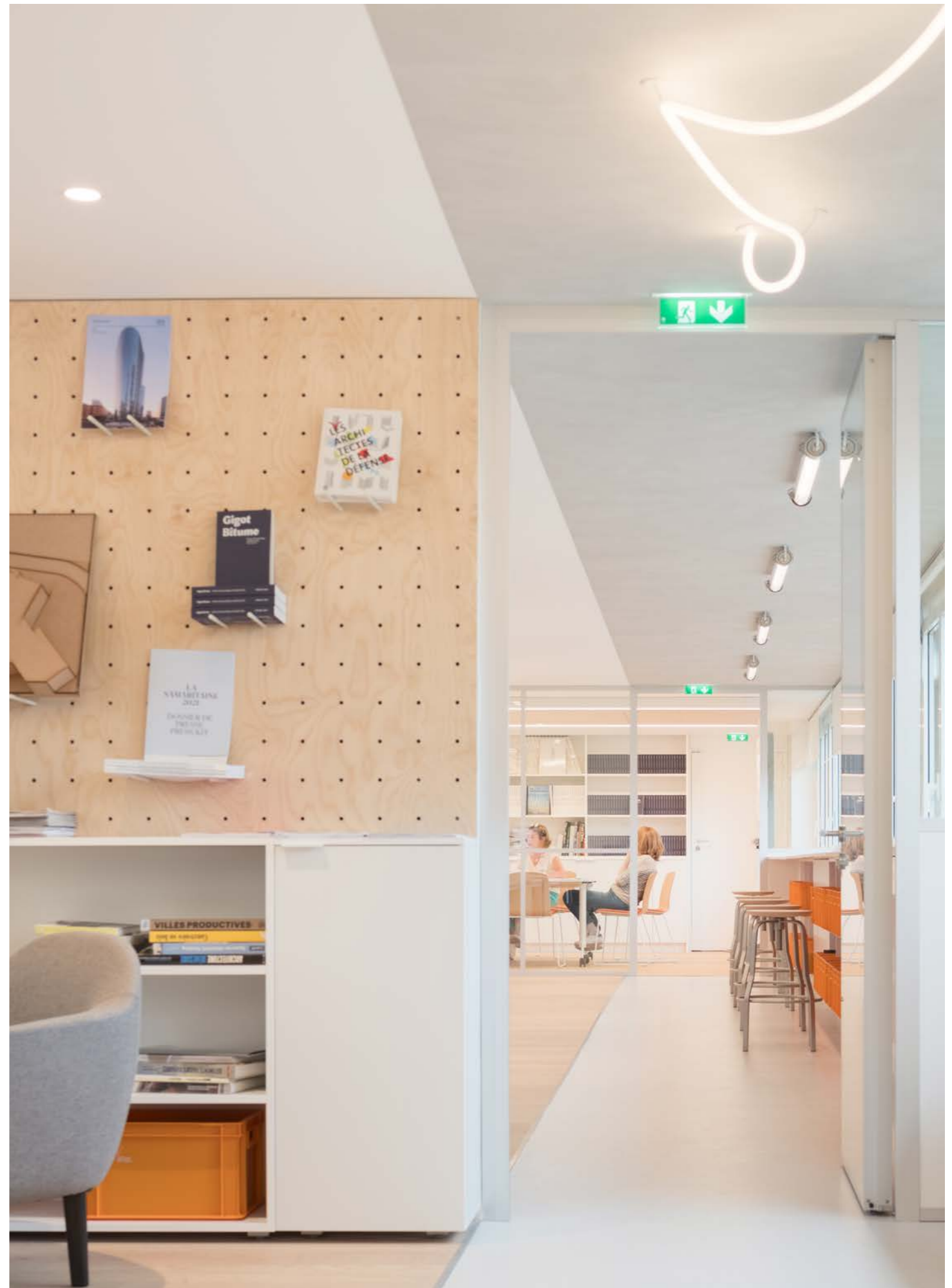

SRA Architects headquarters, Paris, SRA Architects, photo by J. Chulski,  
Spark collection

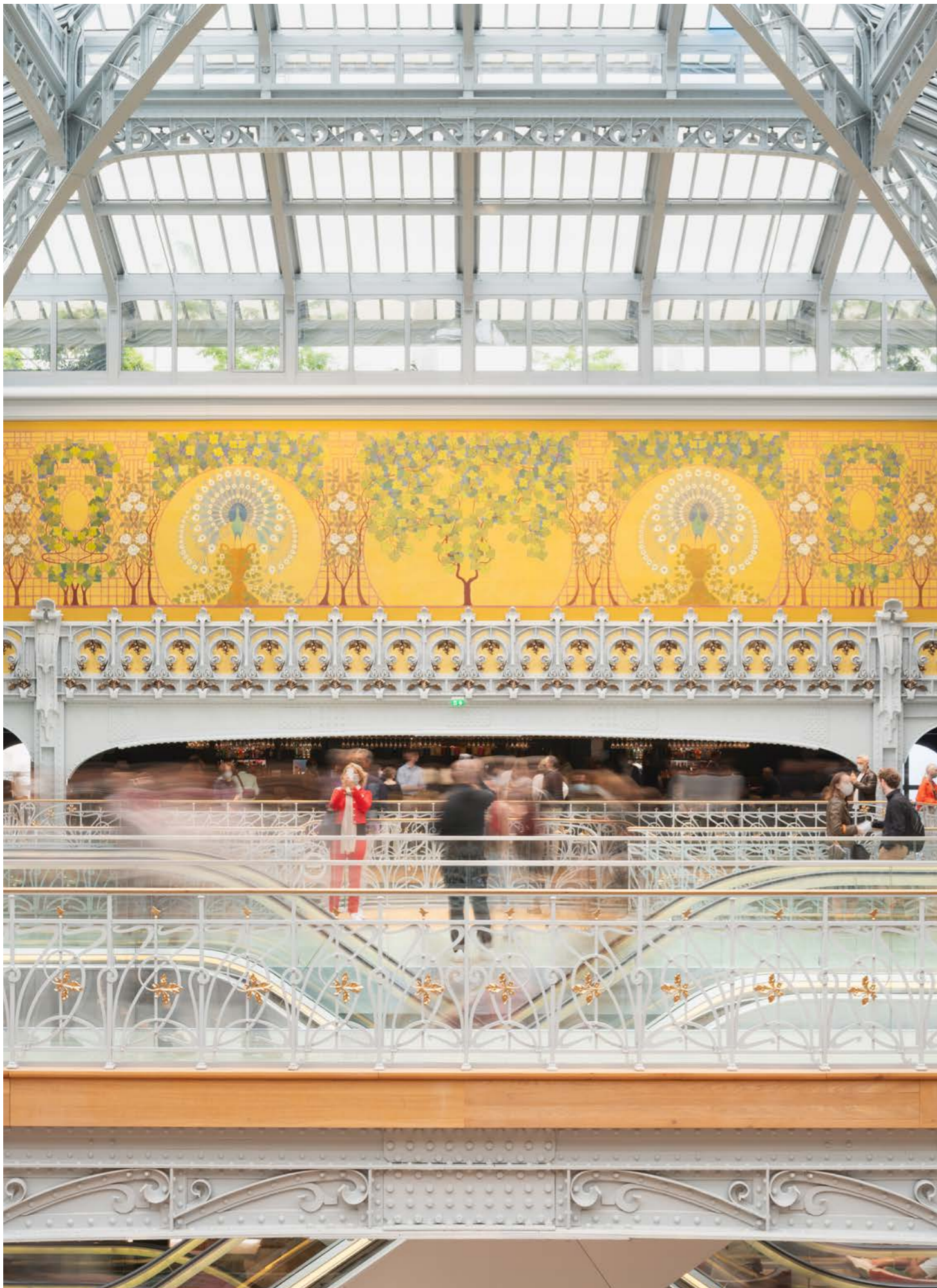

La Samaritaine Paris, SRA Architects, photo by J. Chulski,  
Spark collection



La Samaritaine Paris, SRA Architects, photo by J. Chulski,  
Spark collection



Musée des Arts décoratifs, Paris, Bien Urbain - Architecture firm and Studio Adrien Gardère,  
photo by L.Boegly, Spark collection

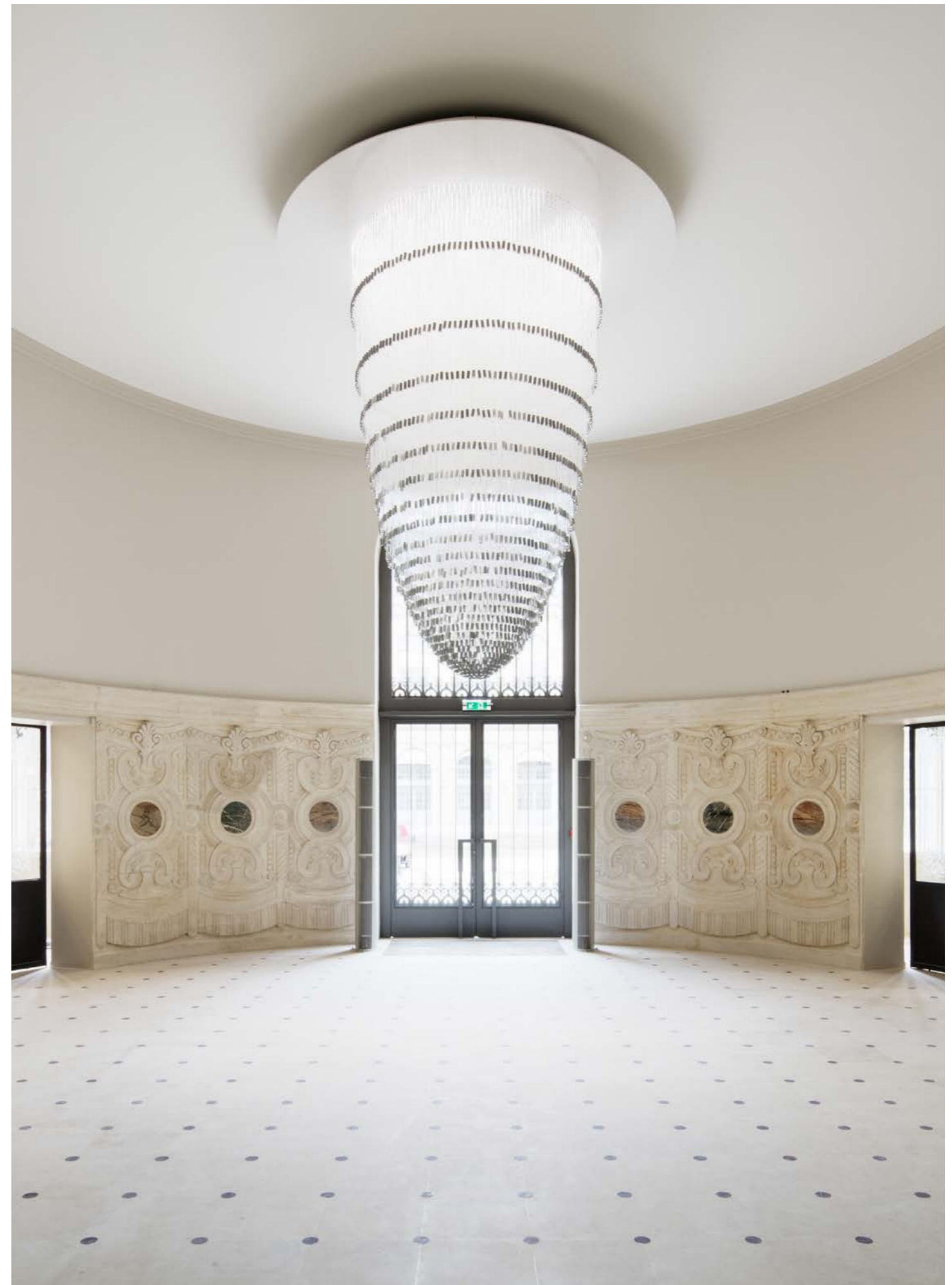

Bibliothèque Nationale de France Richelieu site, Paris, Bruno Gaudin - Architect, photo  
by T.Shimmura, Cylindrik collection



Pathé Parnasse Cinema, Paris, photo by G. Pavarini,  
Vista Cinema collection

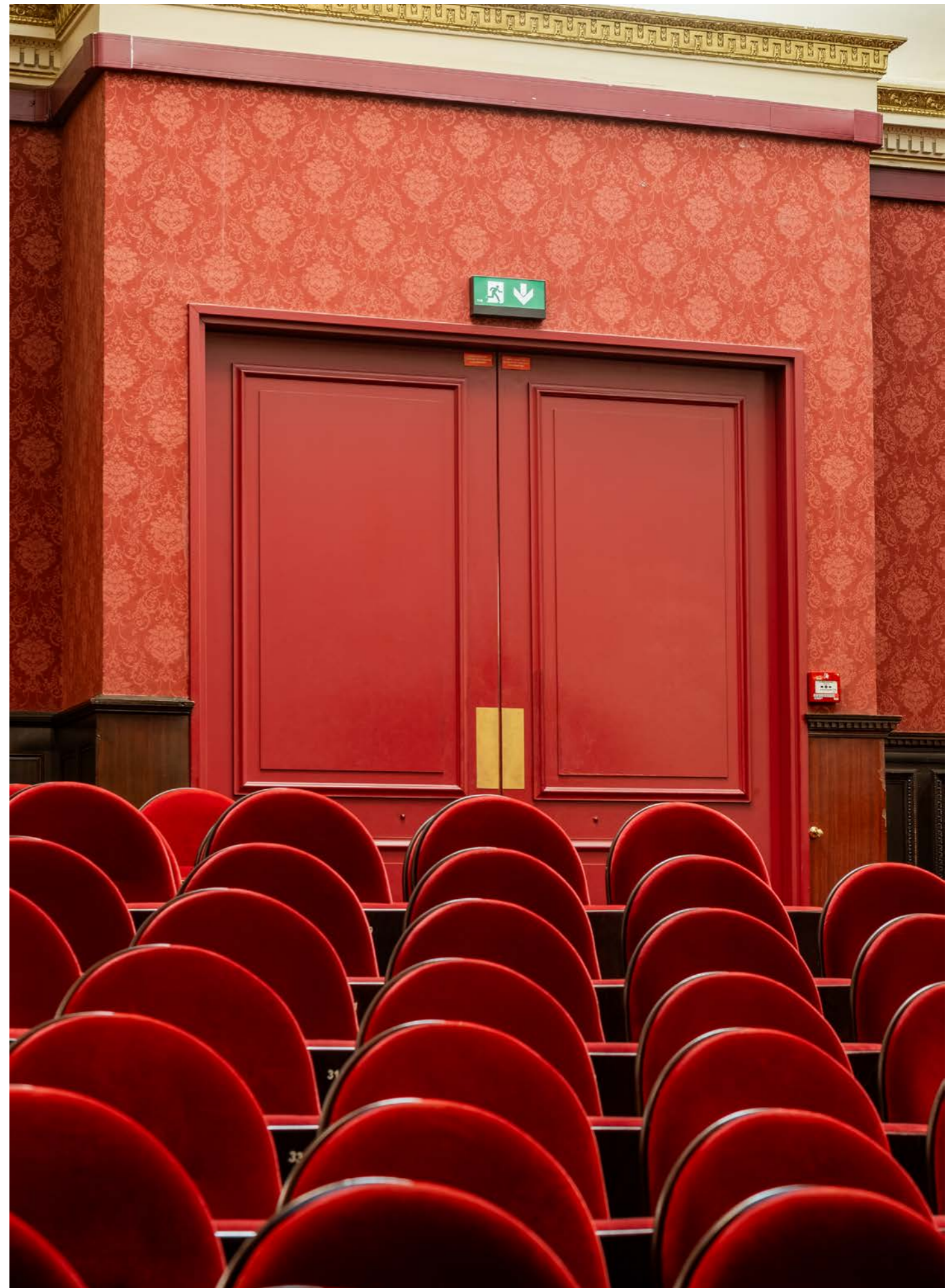

Mogador Theater, Paris, photo by G. Pavarini,  
Vista Cinema collection



Métro Hôpital Lyon Sud, AZC architects, photo by J. Hourcade,  
Spark collection

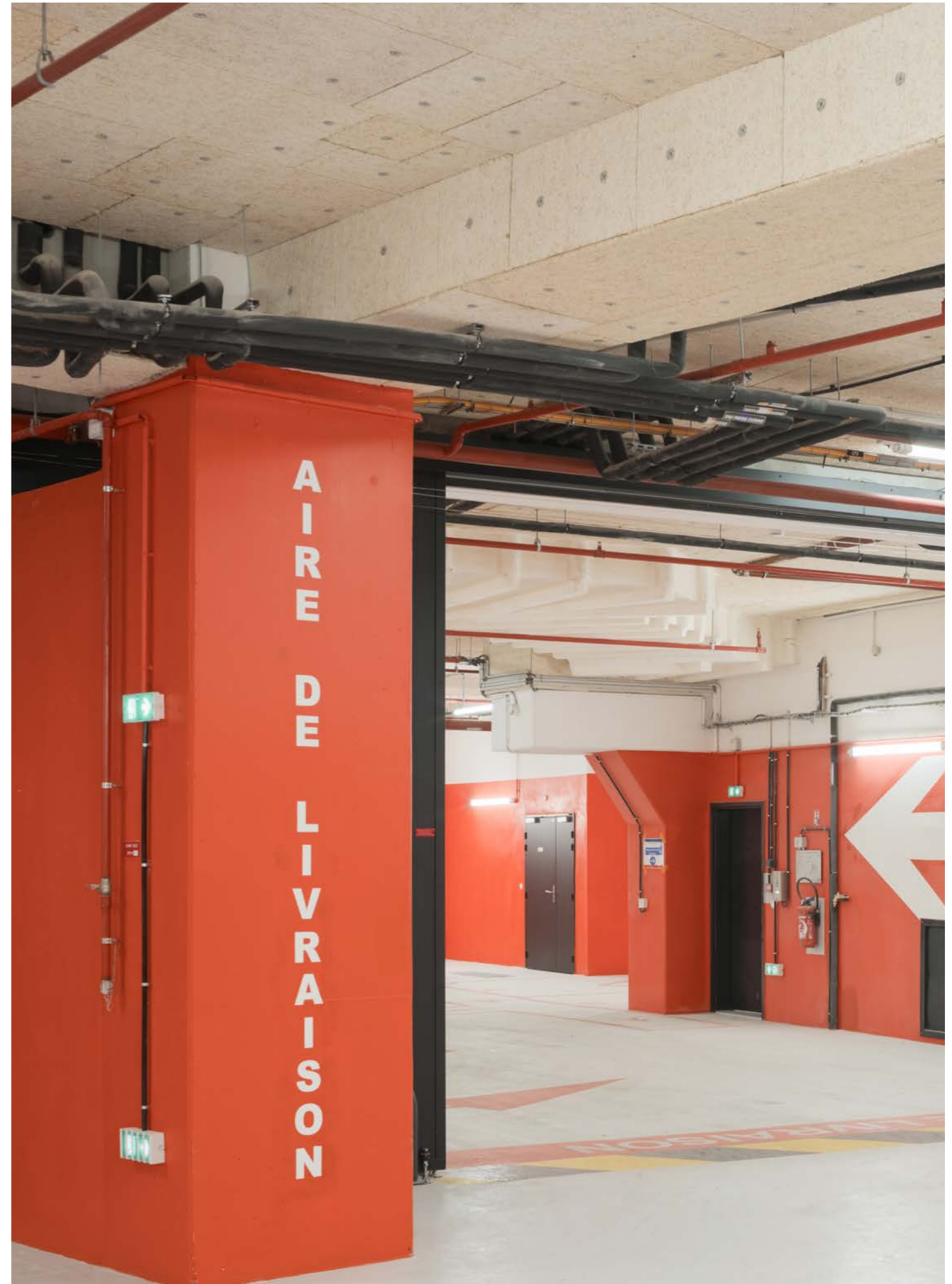

Parking Tour Keiko, Paris, Loci Anima Architectures, photo by J.Chulski,  
Eclat<sup>2</sup> collection



**Béhar sécurité**  
32 avenue Marc Sangnier  
92390 Villeneuve-la-Garenne  
FRANCE  
+33 (0)1 47 88 31 31  
[contact@beharsecurite.com](mailto:contact@beharsecurite.com)  
[beharsecurite.com](http://beharsecurite.com)