

# Offices





**Béhar supports the various stakeholders involved in the design, operation, and maintenance of workspaces — from small independent offices to large corporate complexes.**

**Our expertise, combining technical mastery and innovation, enables us to deliver tailor-made solutions for the optimal and aesthetic integration of emergency lighting, in perfect harmony with the architecture.**

# Design for all architectures

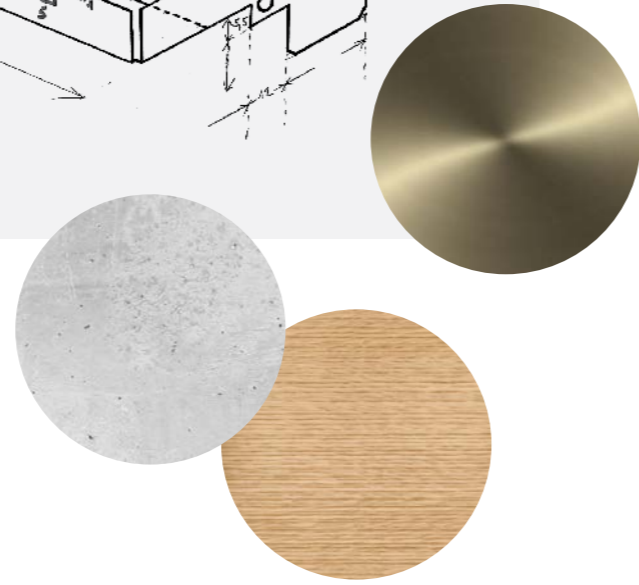
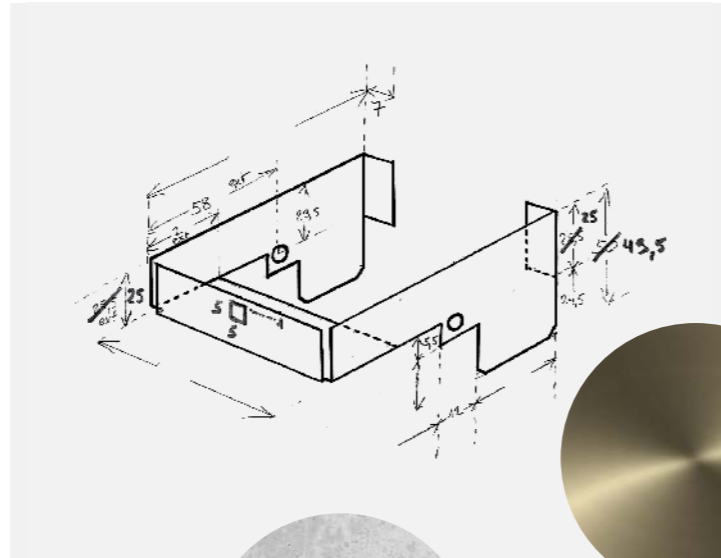
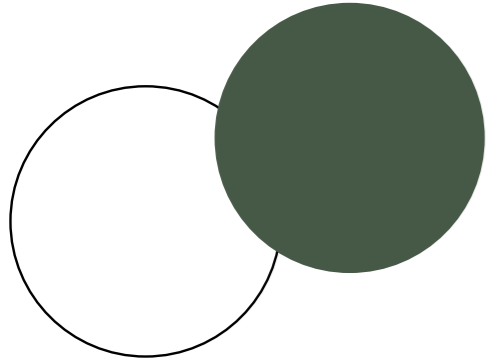

Since 1960, Béhar has been designing emergency lighting fixtures with clean lines, made from sustainable materials.

They blend naturally into any architectural environment.

Every detail can be customized: shape, color, finish, mounting type, accessories, surface treatment, etc., to meet the aesthetic requirements of each project.

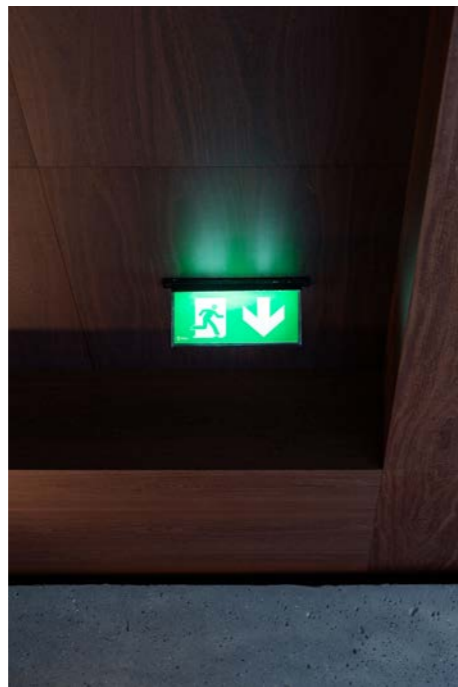

# Customization



Infinite customization — each product can be tailored to the needs of your project and the specific characteristics of the building.



# Our emergency lighting solutions

All our solutions are available in addressable, self-test, power central source, and self-test bi-function versions. Custom solutions and special finishes available on request.

A non-exhaustive selection of our solutions — find our full range on our website:



## Luce



The most compact model on the emergency lighting market.

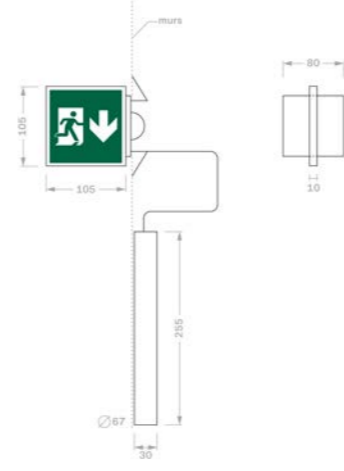

## Spark



Discover the wide range of mounting options for the series on our website.

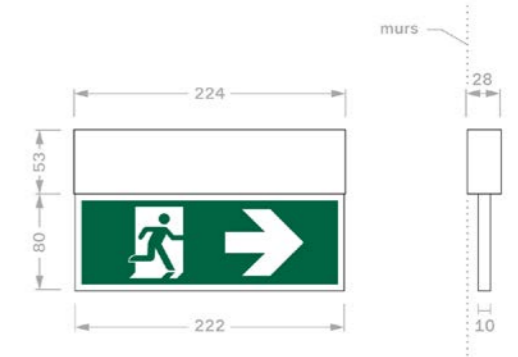

## Knopé



Model made of solid oak.

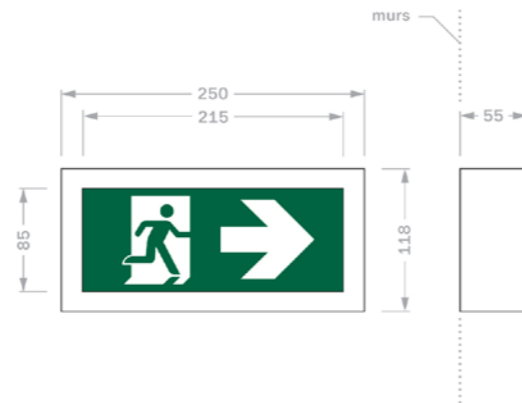

## Eclat



## Lou

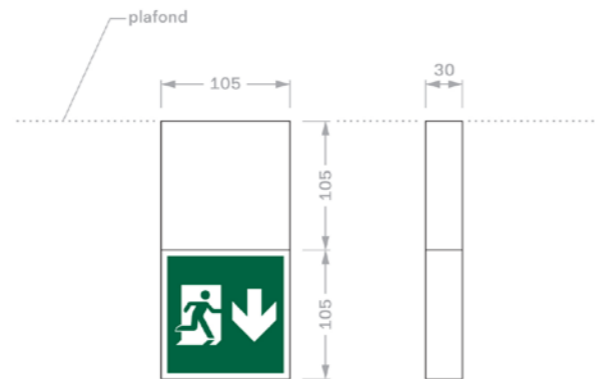
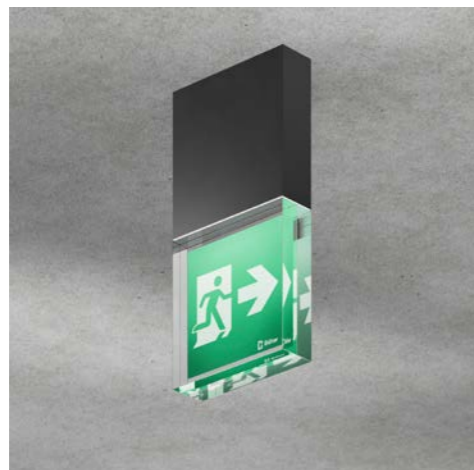

## Star

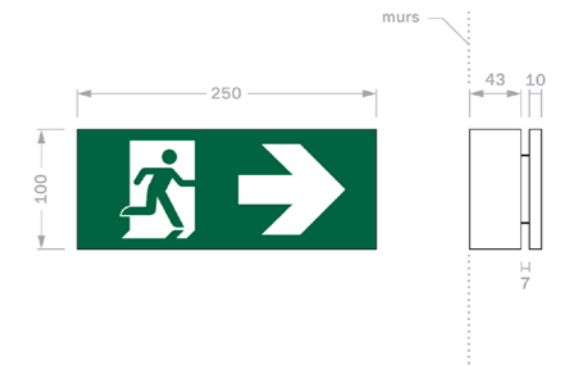

# Our anti-panic and specific sign lighting solutions

All our solutions are available in addressable, self-test, power central source, and self-test bi-function versions. Custom solutions and special finishes available on request.

A non-exhaustive selection of our solutions — find our full range on our website:



## Luce

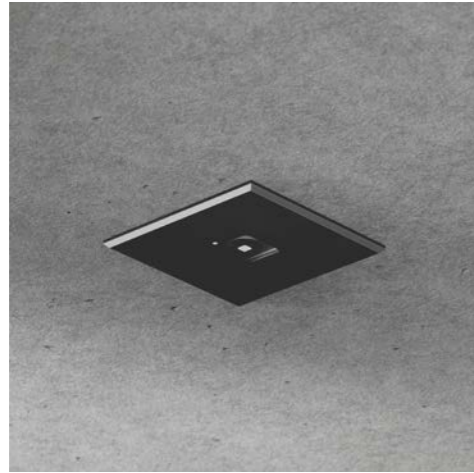

## Clas



Customizable signage pictogram.

## Spark

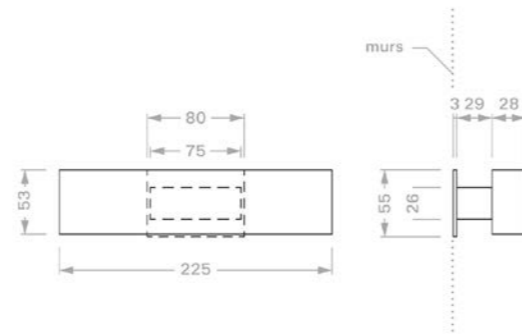

Discover the wide range of mounting options for the series on our website.

## Modernization

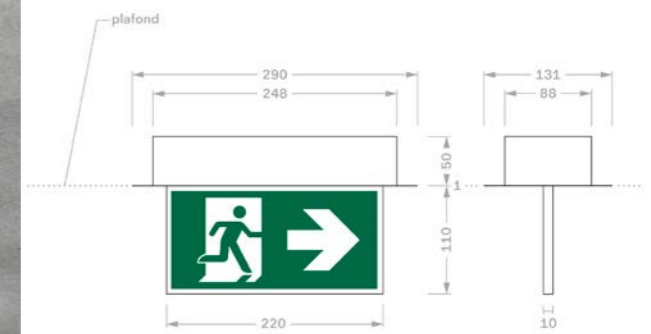

Compatible with all existing cutout dimensions.

## Luce

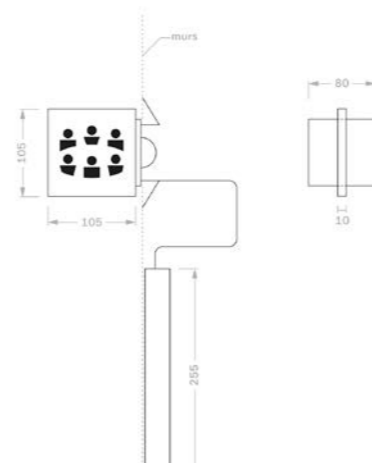
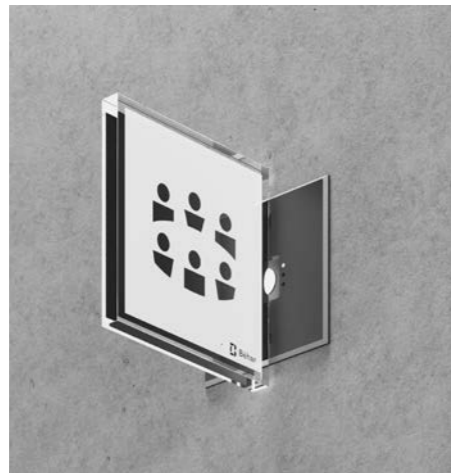

Customizable signage pictogram.

## Smart System

A unique system offering efficiency, safety, and total control.





SRA Architectes Headquarters, Paris, SRA Architects, photo by J. Chulski, Spark collection



SRA Architectes Headquarters, Paris, SRA Architects, photo by J. Chulski, Spark collection



Radio France Headquarters, Paris, SRA Architects, photo by J. Chulski,  
Spark collection

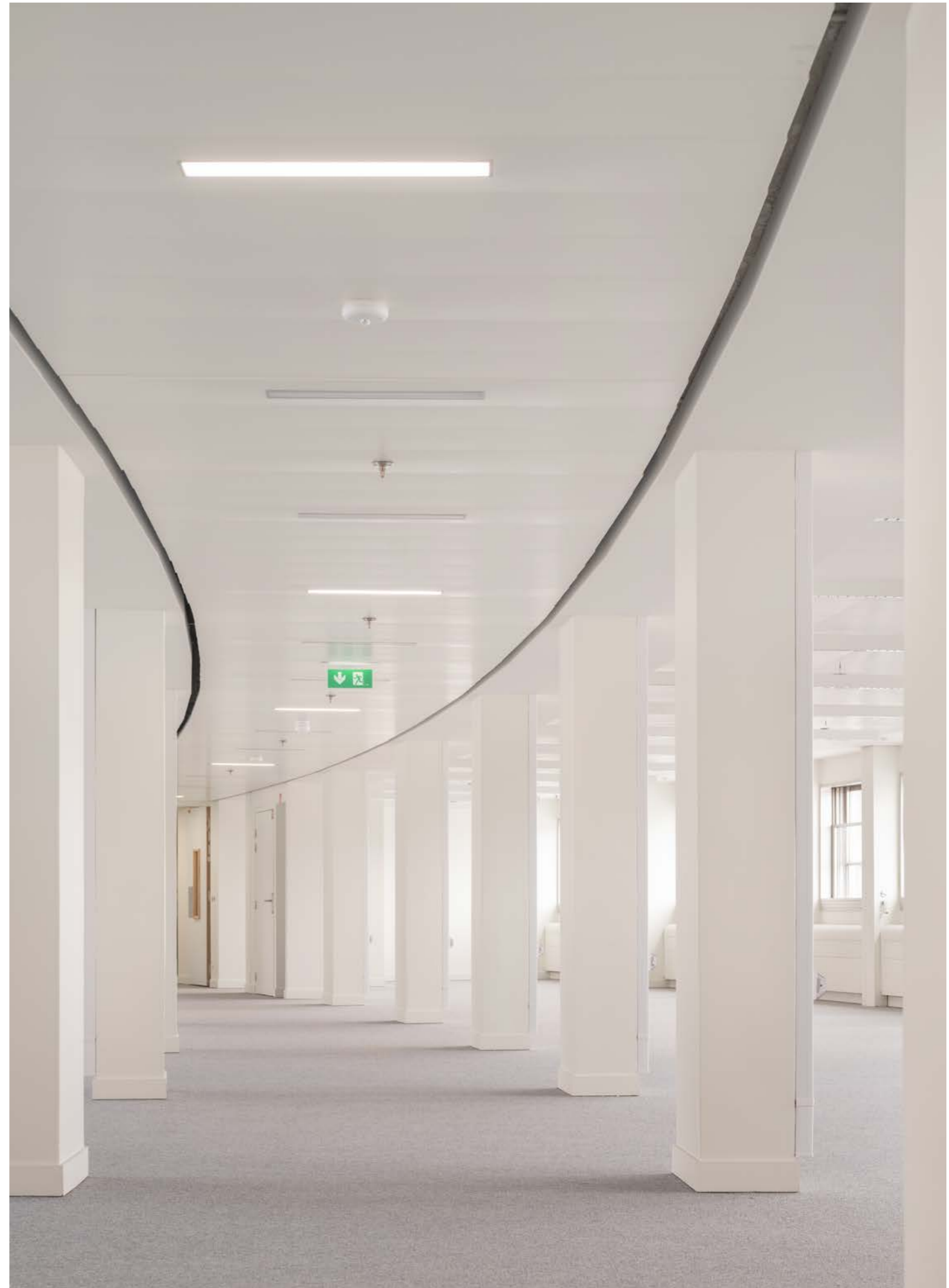

Radio France Headquarters, Paris, SRA Architects, photo by J. Chulski,  
Spark collection



So Pop, Saint-Ouen, Gauthier Pouillart and Mathier Girard Architects, photo by J. Chulski, Spark collection

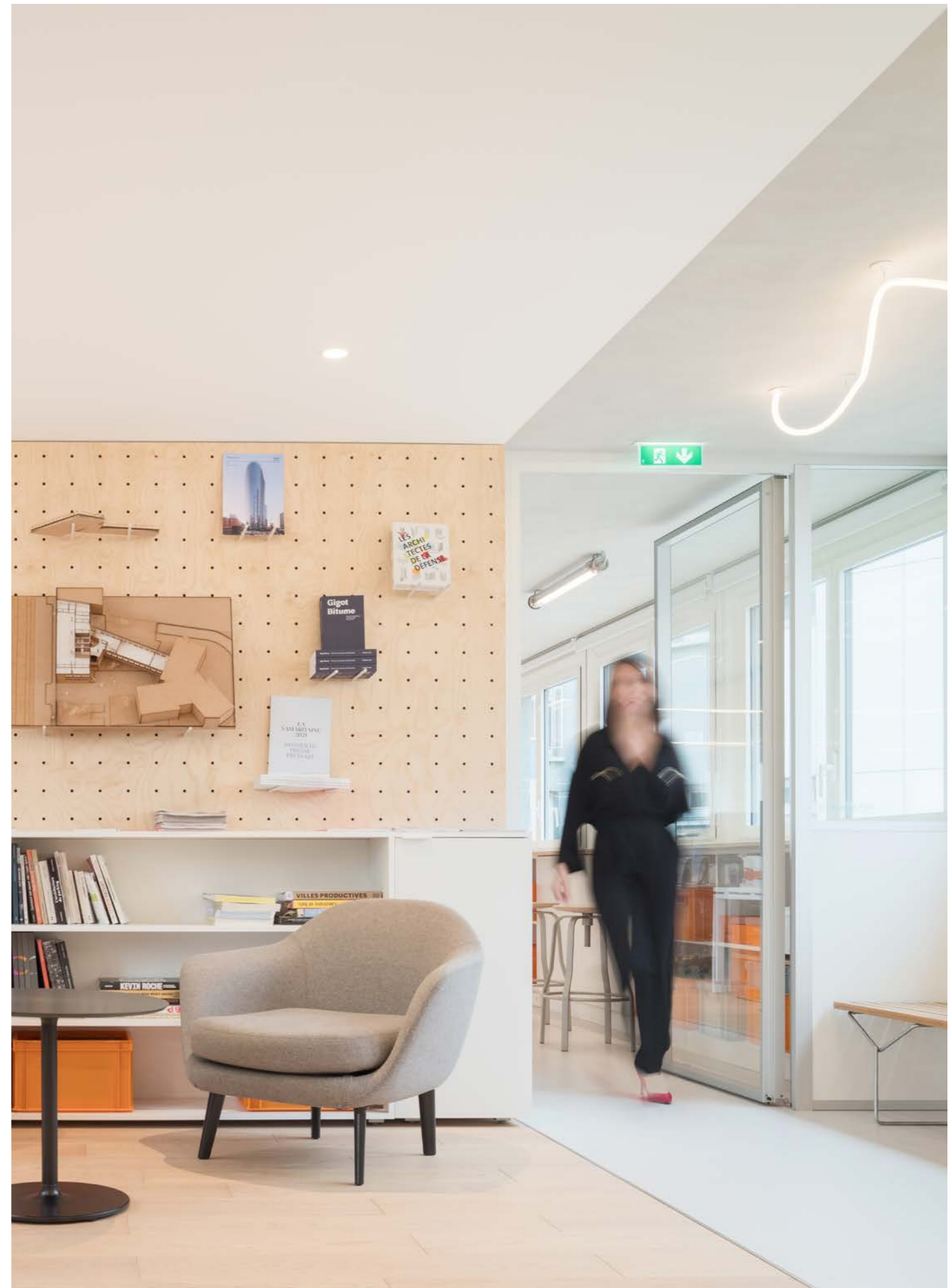

SRA Architectes Headquarters, Paris, SRA Architects, photo by J. Chulski, Spark collection



**Béhar sécurité**  
32 avenue Marc Sangnier  
92390 Villeneuve-la-Garenne  
FRANCE  
+33 (0)1 47 88 31 31  
[contact@beharsecurite.com](mailto:contact@beharsecurite.com)  
[beharsecurite.com](http://beharsecurite.com)